

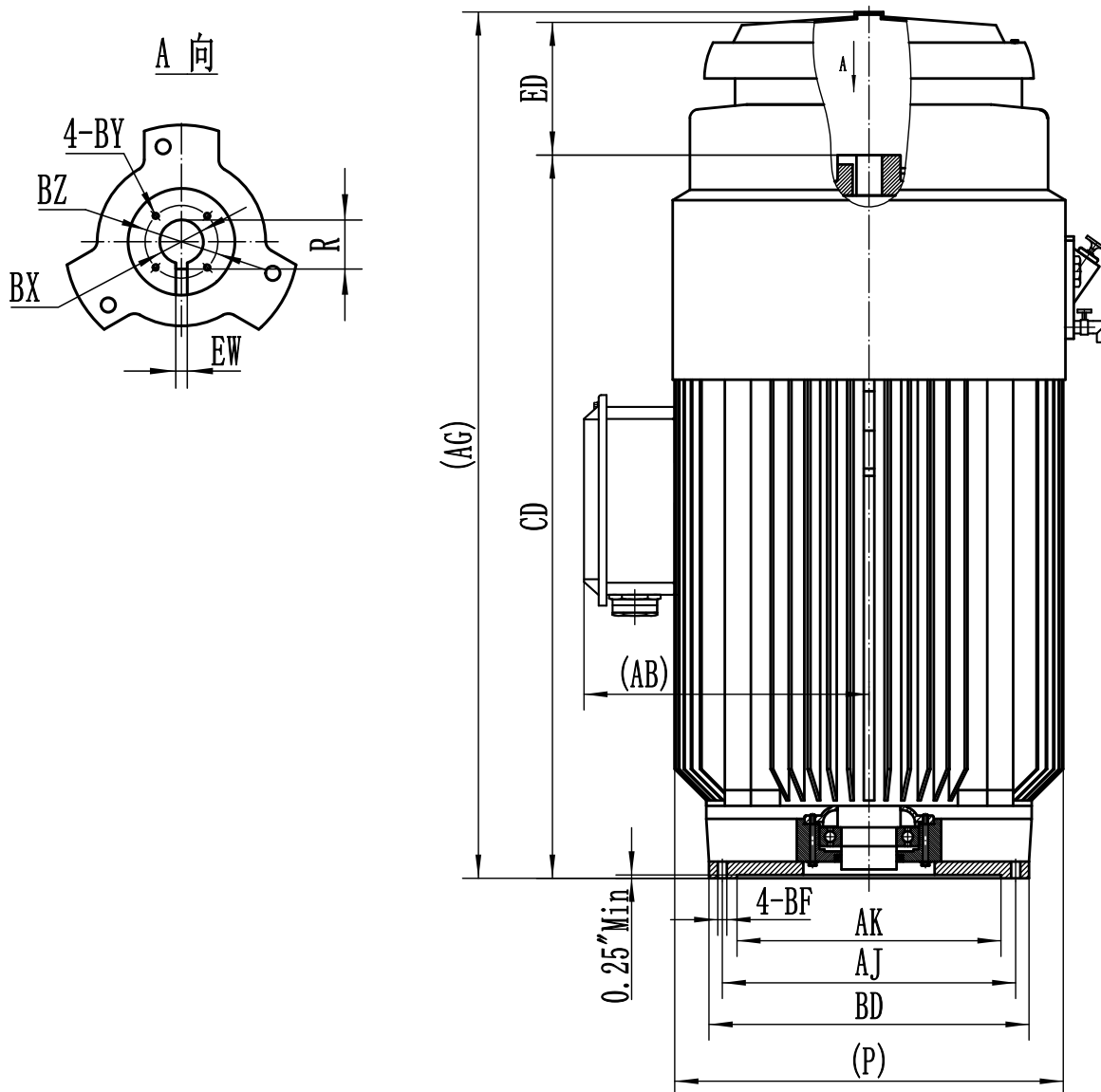

MOTOR DIMENSIONS - 360TP TEFC



MOUNTING DIMENSIONS - 360TP TEFC

FRAME	MOUNTING DIMENSIONS(INCH)												
	HP	BD	AJ	AK	BF	BX	BZ	EW	R	BY	CD	AB	AG
VHS364TP-4	60	16.5	14.75	13.5	0.69	1.25	1.75	0.2	1.367	1/4-20	31.16	15.5	39.4
VHS365TP-4	75	16.5	14.75	13.5	0.69	1.25	1.75	0.2	1.367	1/4-20	31.16	15.5	39.4