

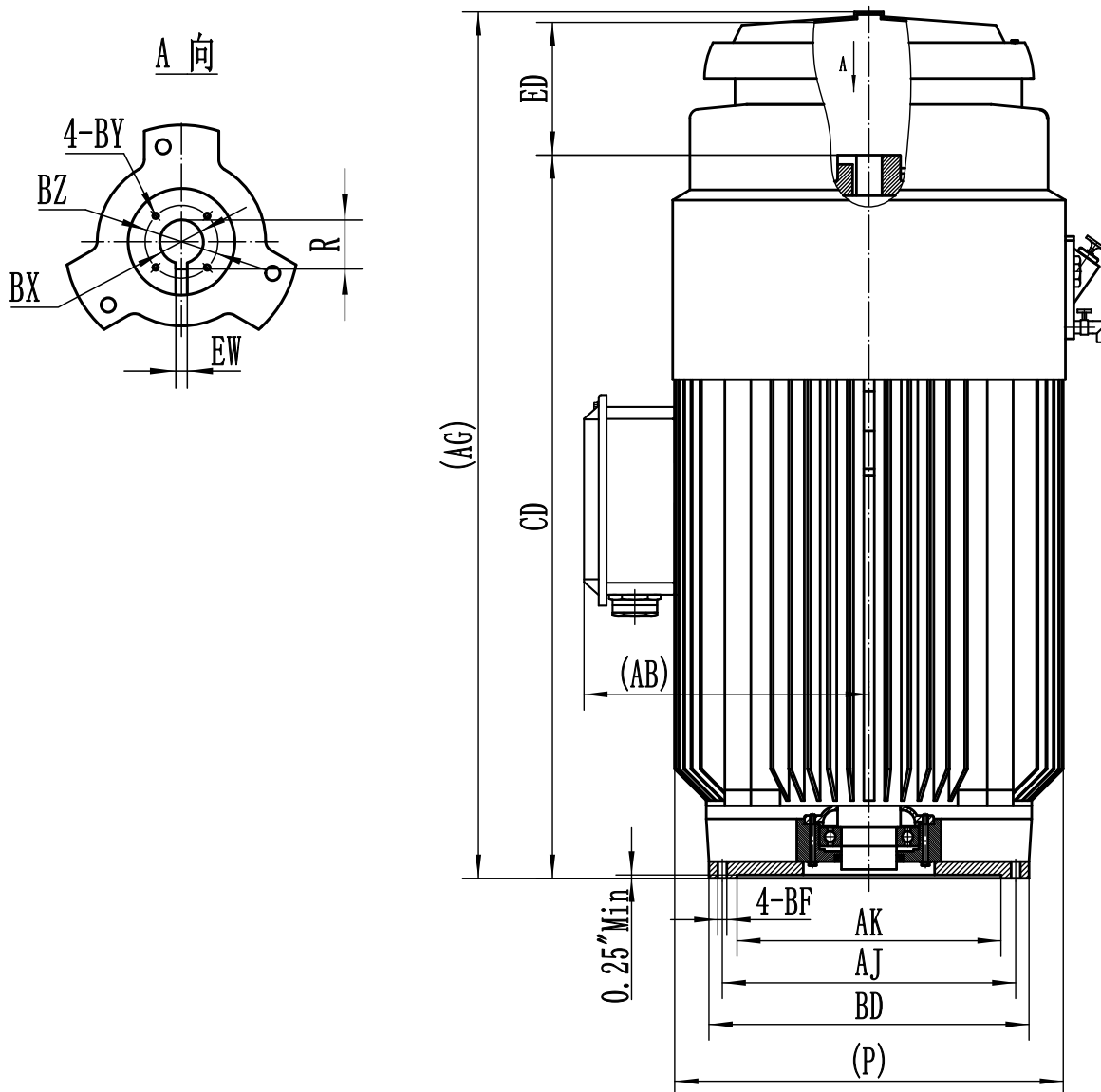

MOTOR DIMENSIONS - 320TP TEFC



MOUNTING DIMENSIONS - 320TP TEFC

FRAME	MOUNTING DIMENSIONS(INCH)												
	HP	BD	AJ	AK	BF	BX	BZ	EW	R	BY	CD	AB	AG
VHS324TP-4	40	16.5	14.75	13.5	0.69	1.25	1.75	0.2	1.367	1/4-20	28.22	15.5	36.4
VHS326TP-4	50	16.5	14.75	13.5	0.69	1.25	1.75	0.2	1.367	1/4-20	28.22	15.5	36.4