

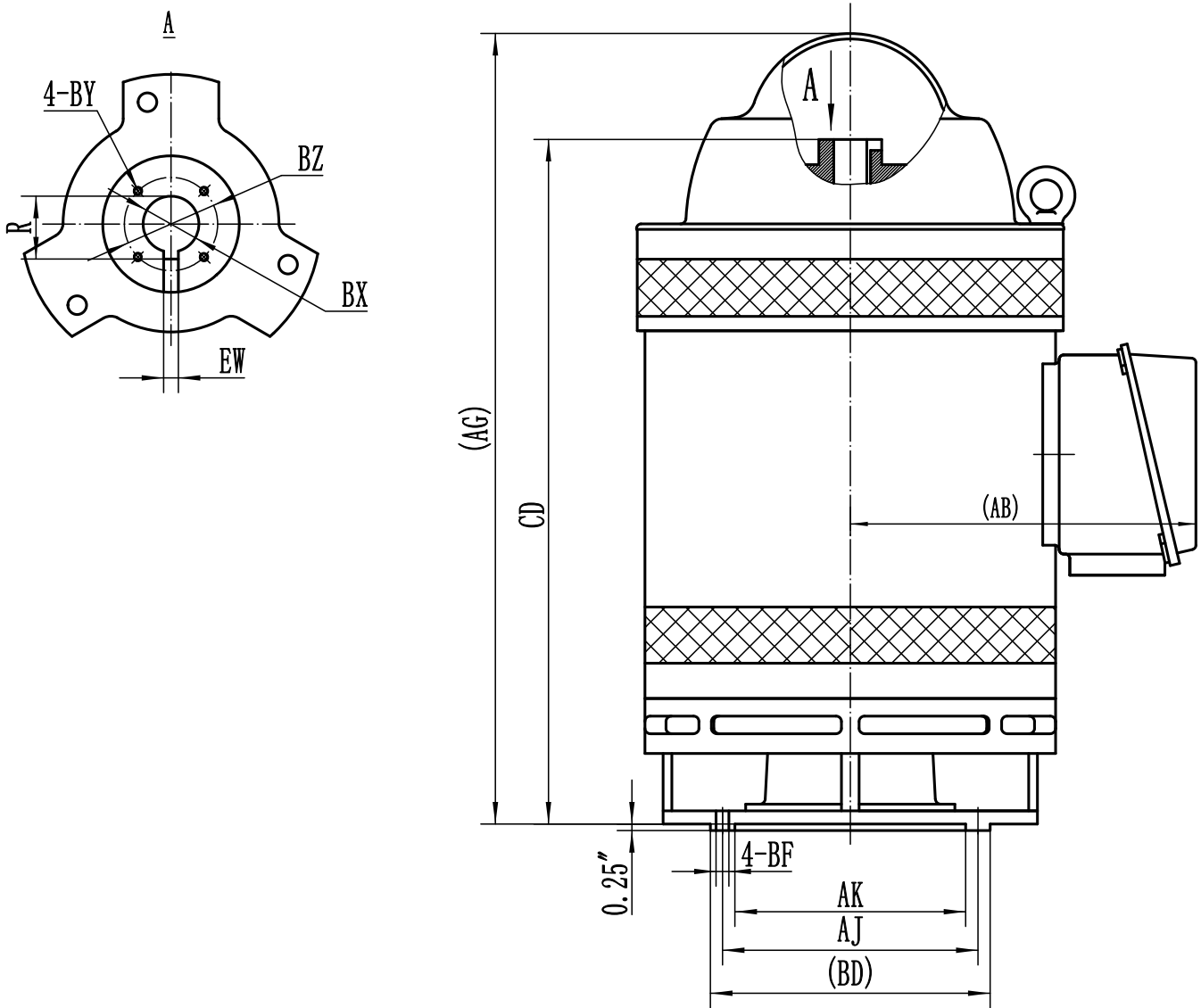

MOTOR DIMENSIONS - 250TP



MOUNTING DIMENSIONS - 250TP

FRAME	MOUNTING DIMENSIONS(INCH)												
	HP	BD	AJ	AK	BF	BX	BZ	EW	R	BY	CD	AB	AG
VHS254TP-4	15	10	9.125	8.25	0.44	1	1.38	0.2	1.13	1/4-20	23.38	14.3	27.1
VHS256TP-4	20	10	9.125	8.25	0.44	1	1.38	0.2	1.13	1/4-20	23.38	14.3	27.1